

UK Model
AEP Model

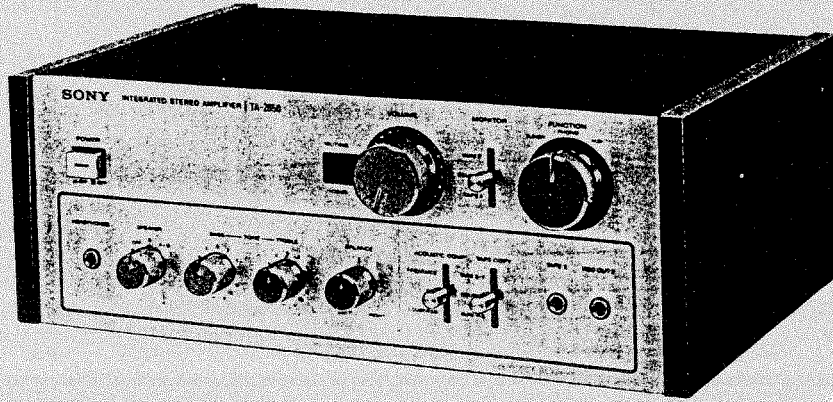

INTEGRATED STEREO AMPLIFIER

SPECIFICATIONS

GENERAL

Power Requirements:	110, 127, 220 or 240 V ac adjustable, 50/60 Hz
Power Consumption:	275 W (UK model) 400 W (AEP model)
Dimensions:	Approx. 390 (w) x 145 (h) x 290 (d) mm 15 1/8 (w) x 5 3/4 (h) x 11 1/4 (d) inches Including projecting parts and controls
Weight:	Approx. 8.65 kg, 19 lb 1 oz (net) Approx. 10.5 kg, 23 lb 3 oz (with shipping carton)

Dynamic Power Output:	150 W (8 Ω)
(IHF constant power supply method)	170 W (4 Ω) (AEP model)
Power Bandwidth:	10 - 40,000 Hz, IHF
Damping Factor:	25 (8 Ω , at 1 kHz)
Harmonic Distortion:	Less than 0.2 % at rated output Less than 0.15 % at 1 W output
IM Distortion:	Less than 0.2 % at rated output (60 Hz: 7 kHz=4:1) Less than 0.15 % at 1 W output
Residual Noise:	Less than 0.25 μ W (3 Ω)

AMPLIFIER SECTION

Continuous RMS Power Output:	Both channels driven simultaneously
(rated output)	At 20 - 20,000 Hz 43 + 43 W (8 Ω)
(Less than 0.2 % harmonic distortion)	At 1 kHz 48 + 48 W (8 Ω) 58 + 58 W (4 Ω) (AEP model)
	According to DIN 45,500 43 + 43 W (8 Ω)

- Continued on page 2 -

SONY[®]
SERVICE MANUAL

— Contidued from page 1 —

Inputs:

	Sensitivity	Impedance	Maximum Input Capability (THD 0.2 %)	S/N (weighting network, input level)
PHONO	2.5 mV (-50 dB)	50 k Ω	200 mV	70 dB (B, 2.5 mV)
TUNER AUX TAPE1, 2 REC/PB	150 mV (-14.5 dB)	100 k Ω	—————	90 dB (A, 150 mV)

Outputs:

	Output Level	Impedance
REC OUT 1, 2	150 mV	10 k Ω
REC/PB	30 mV	82 k Ω
HEADPHONES	Accepts low and high impedance headphones	
SPEAKERS	Accepts speakers of 4 – 16 Ω (AEP model)	
	Accepts soeakers of 8 Ω or more (UK model)	

Frequency Response: PHONO RIAA equalization curve ± 0.5 dB

TUNER	} 10 Hz – 100 kHz	+0 -2 dB
AUX		
TAPE 1, 2		
REC/PB (input)		

Tone Controls: BASS
 ± 9 dB at 100 Hz (turnover freq 250 Hz)

TREBLE
 ± 6.5 dB at 10 kHz (turnover freq 4 kHz)

LOUDNESS: +8.8 dB at 50 Hz, 2.5 dB at 10 kHz
(att. 30 dB)

PRESENCE: +2.5 dB at 1 kHz
(att. 30 dB)

0 dB = 0.775 V

IDENTIFICATION OF SET

TA-2650 is classified by the specification label as shown below.

	Specification Label		
UK Model	<table border="1"><tr><td>SONY[®]</td><td>INTEGRATED STEREO AMPLIFIER MODEL NO. TA-2650 AC 110, 127, 220, 240V~50 60Hz 275W SERIAL NO. _____ MADE IN JAPAN</td></tr></table>	SONY [®]	INTEGRATED STEREO AMPLIFIER MODEL NO. TA-2650 AC 110, 127, 220, 240V~50 60Hz 275W SERIAL NO. _____ MADE IN JAPAN
SONY [®]	INTEGRATED STEREO AMPLIFIER MODEL NO. TA-2650 AC 110, 127, 220, 240V~50 60Hz 275W SERIAL NO. _____ MADE IN JAPAN		
AEP Model	<table border="1"><tr><td>SONY[®]</td><td>INTEGRATED STEREO AMPLIFIER MODEL NO. TA-2650 AC 110, 127, 220, 240V~50 60Hz 400W SERIAL NO. _____ MADE IN JAPAN</td></tr></table>	SONY [®]	INTEGRATED STEREO AMPLIFIER MODEL NO. TA-2650 AC 110, 127, 220, 240V~50 60Hz 400W SERIAL NO. _____ MADE IN JAPAN
SONY [®]	INTEGRATED STEREO AMPLIFIER MODEL NO. TA-2650 AC 110, 127, 220, 240V~50 60Hz 400W SERIAL NO. _____ MADE IN JAPAN		

SECTION 1
OUTLINE

BLOCK DIAGRAM

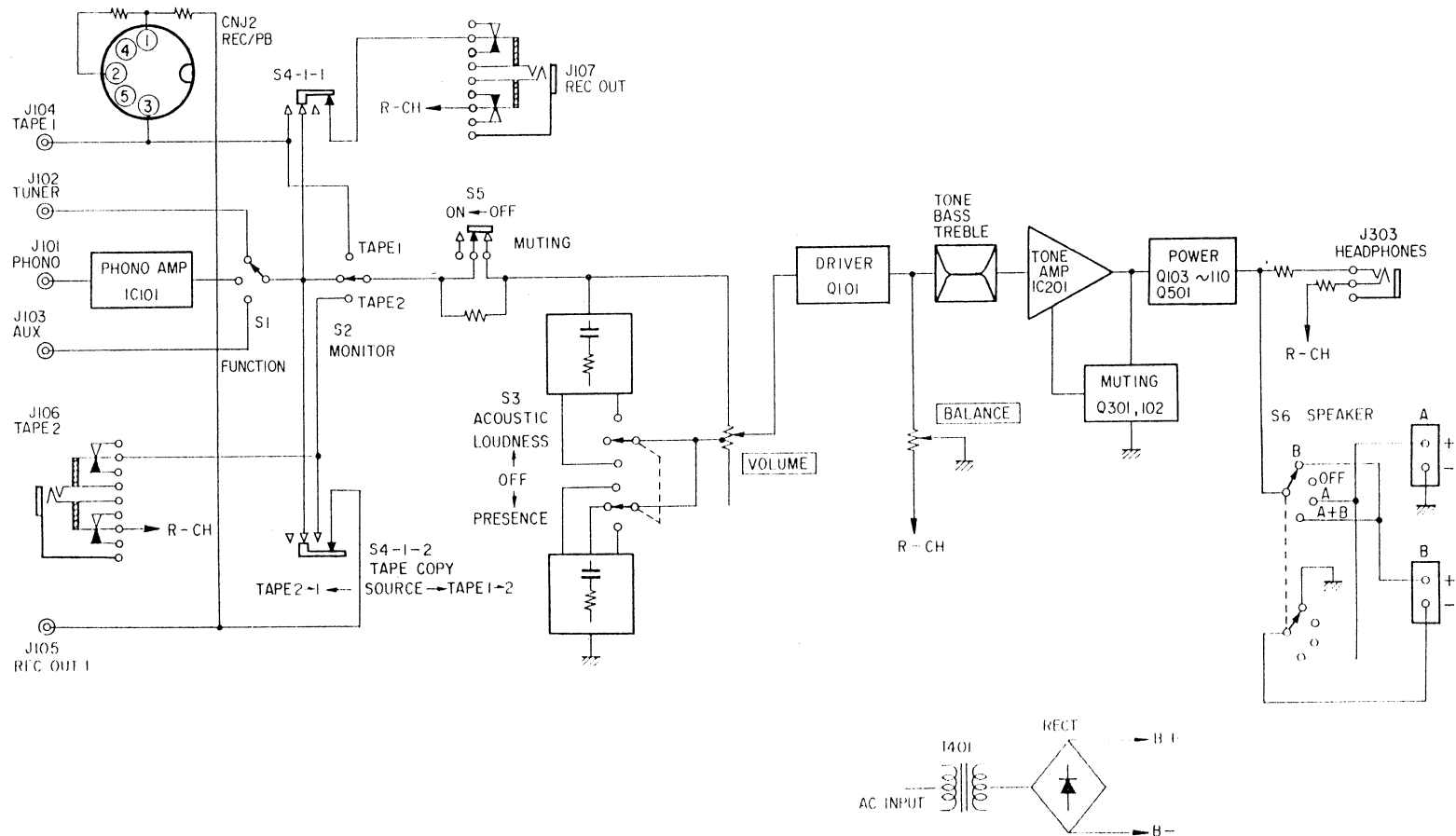

SECTION 2 DISASSEMBLY

2-1. REMOVALS

SIDE BOARD and TOP COVER

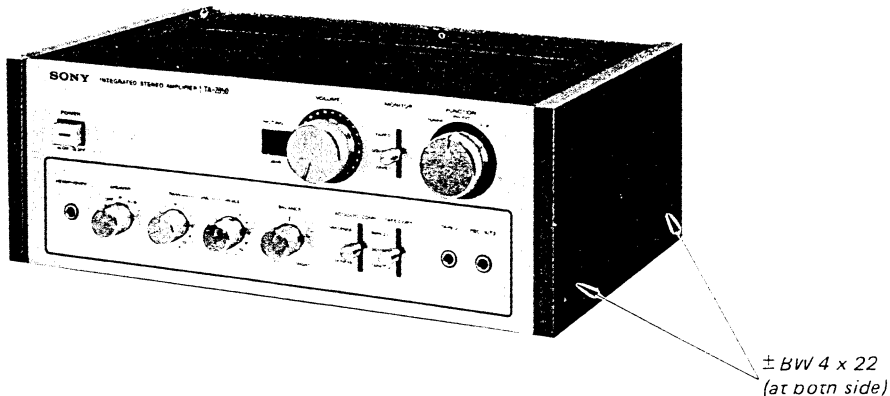

POWER AMP BOARD

④ Remove the power amp board with the heat sink.

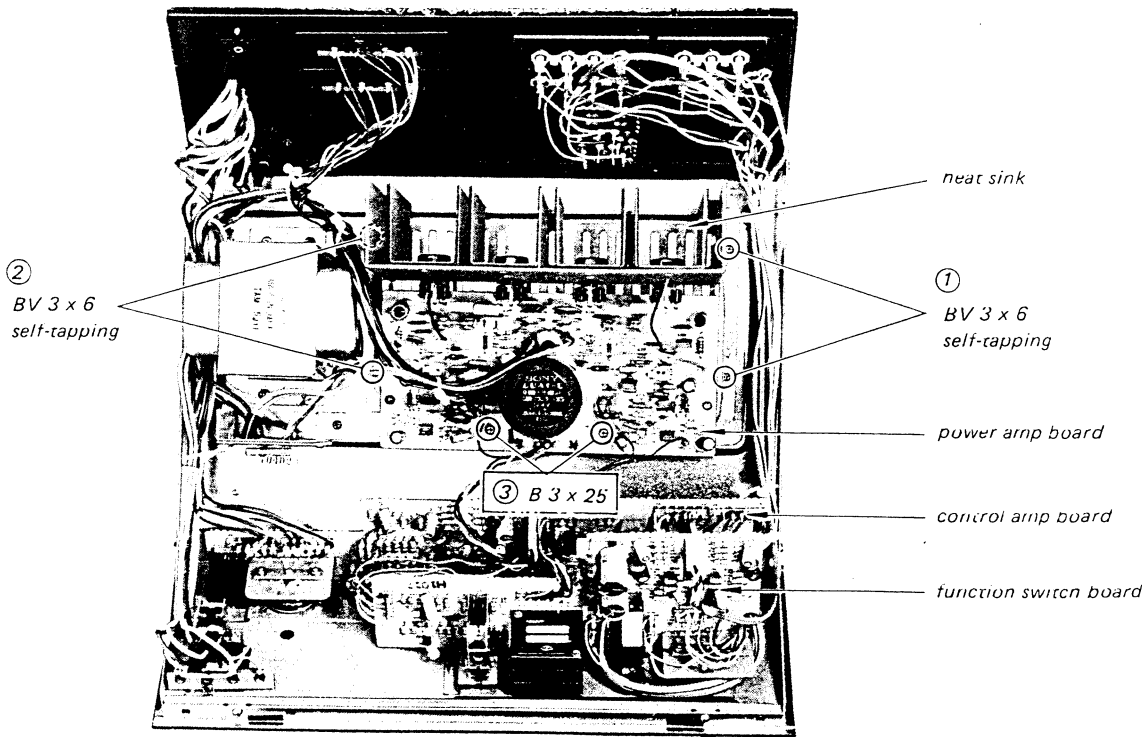

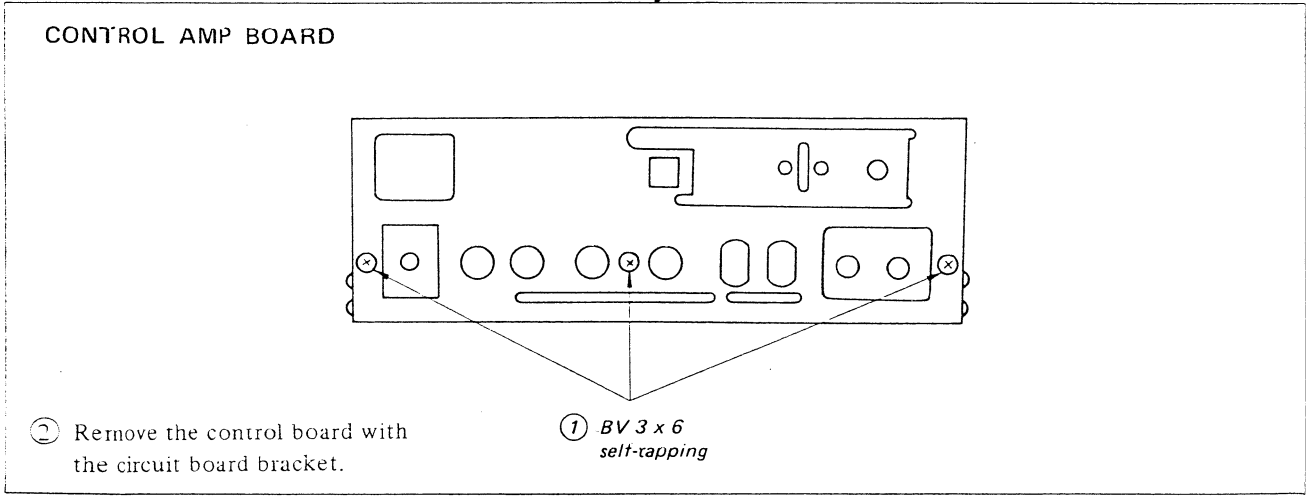
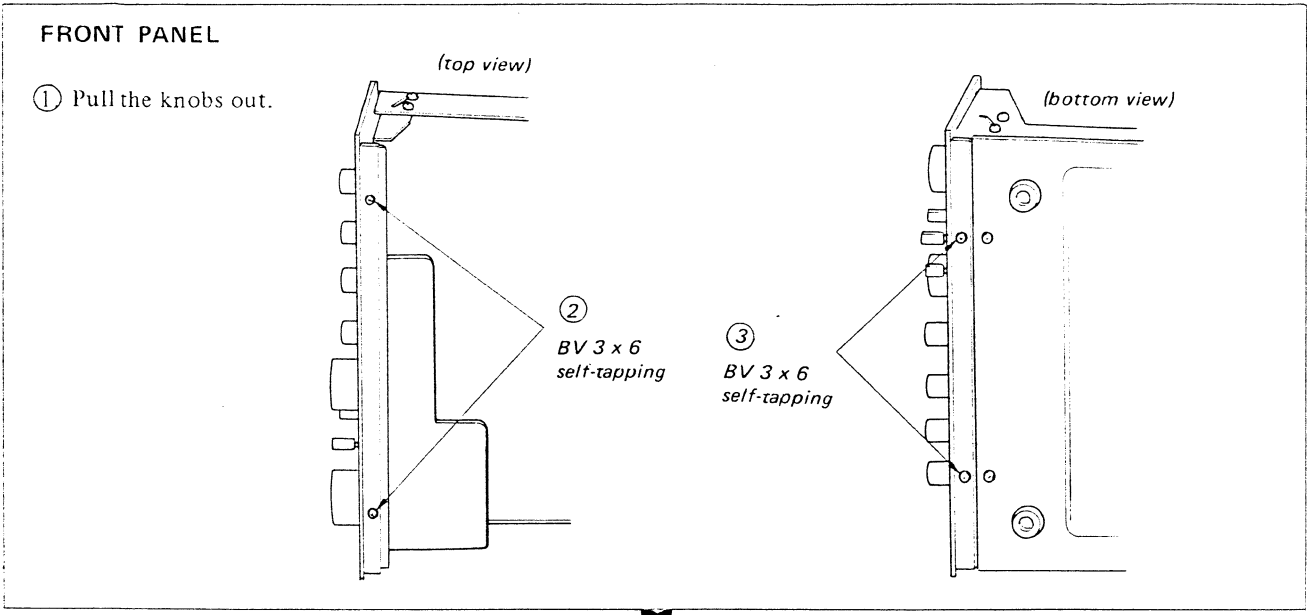

2-2. HOW TO RAISE THE CIRCUIT BOARDS (FUNCTION SWITCH and CONTROL AMP BOARDS)

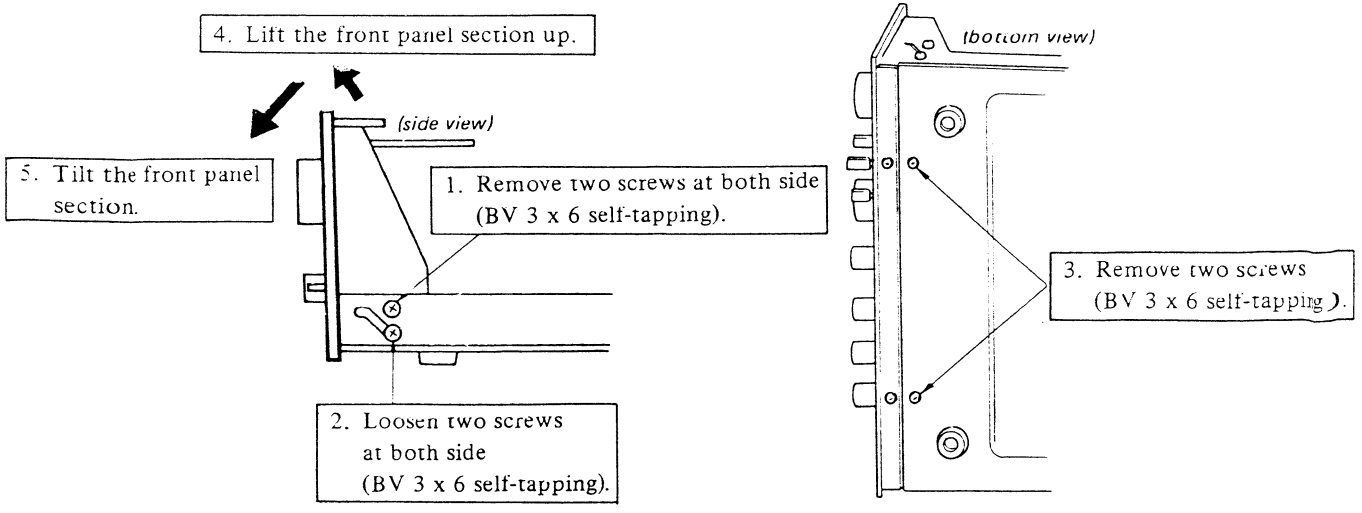

SECTION 3
ADJUSTMENT

2-1. DC BIAS ADJUSTMENT

Adjust RV171 and RV271 for specified values.

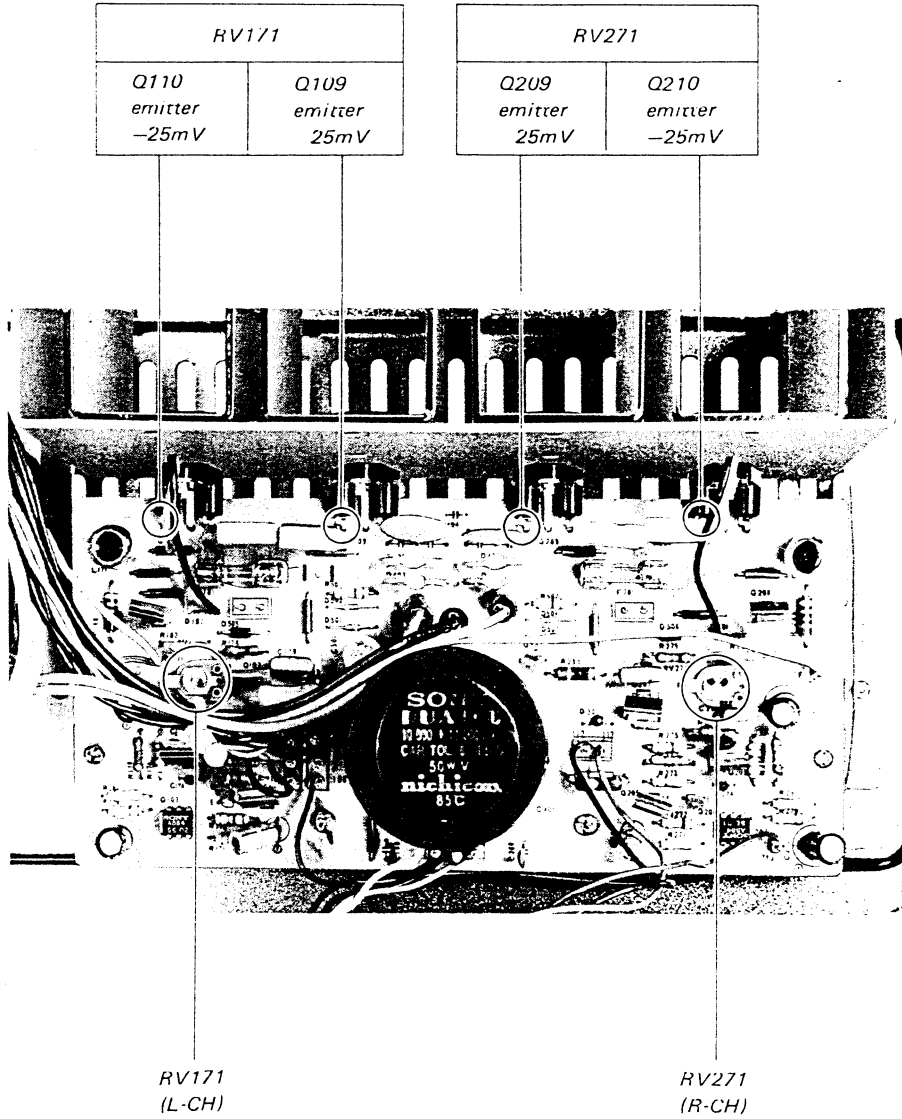

SECTION 4
DIAGRAMS

4-1. MOUNTING DIAGRAM
- Component Side -

IC101, 201: CX046
• B+ pattern
• B- pattern

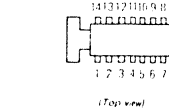

Q101, 201: 2SC1362
Q301: 2SC1364

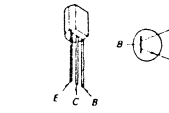

Q102, 202: 2SC1637
Q501: 2SC634

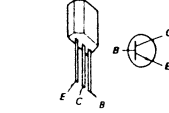

Q103, 203: 2SA884

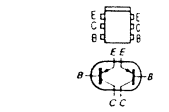

Q104, 204, 502: 2SA678

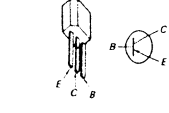

Q105, 108, 205, 208: 2SA706

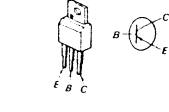

Q106, 107, 206, 207: 2SC1124

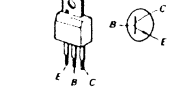

Q109, 209: 2SD532

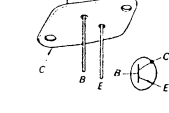

Q110, 210: 2SB518 D101, 201: SV04F

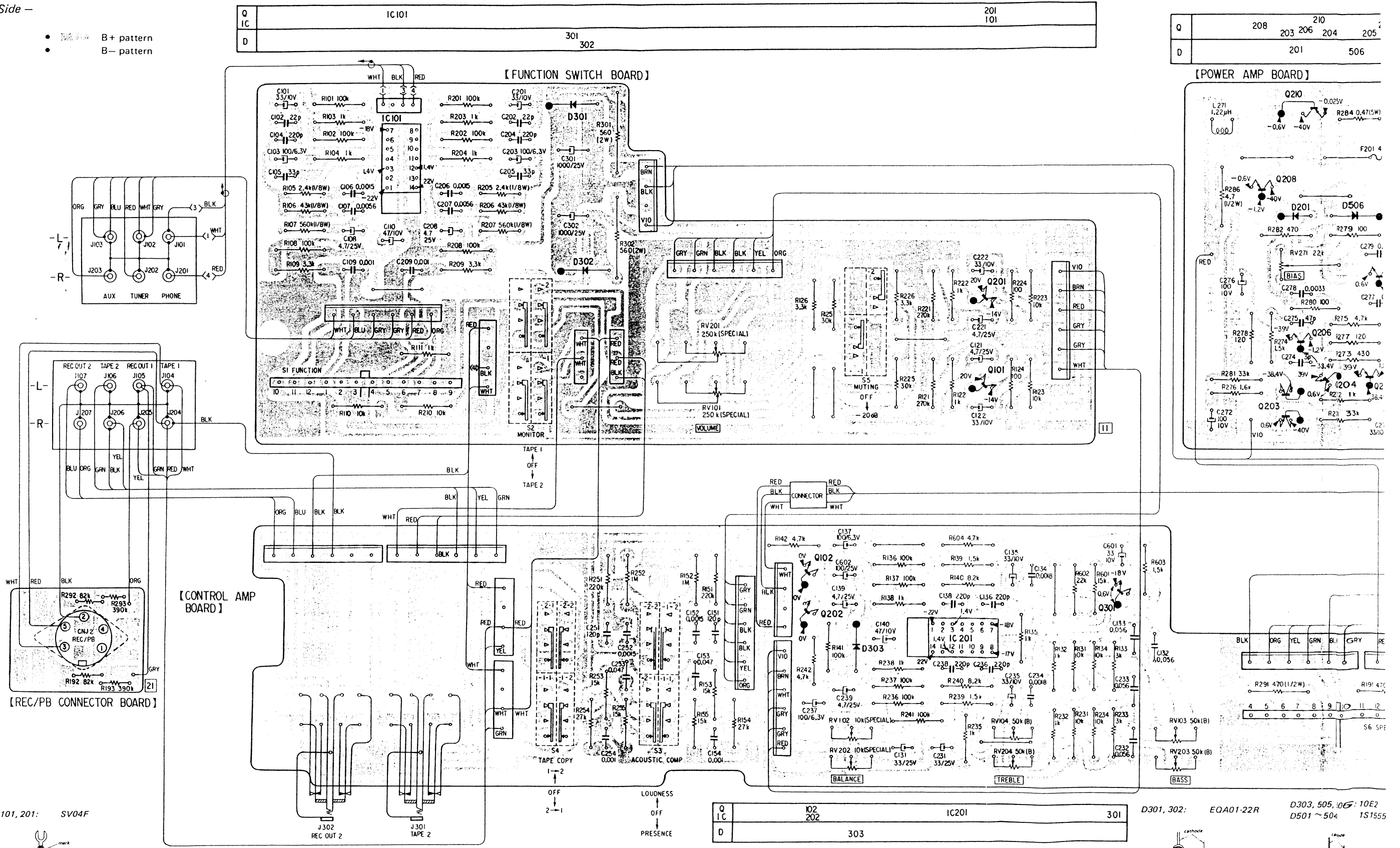
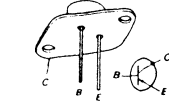

Q		IC101		201
IC			301	101
D			302	

Q		208	210	203	206	204	205
D				201			506

Q		I02		IC201		301
IC		202				
D			303			

D301, 302: EQA01-22R
D303, 505, 106: 10E2
D501 ~ 504: 1S1555

TA-2650 TA-2650

Q	208	203	206	204	205	207	209	501	502	109	107	104	110	108
D	201	506	304	504	503	404	401	402	403	502	501	505	101	

201
101

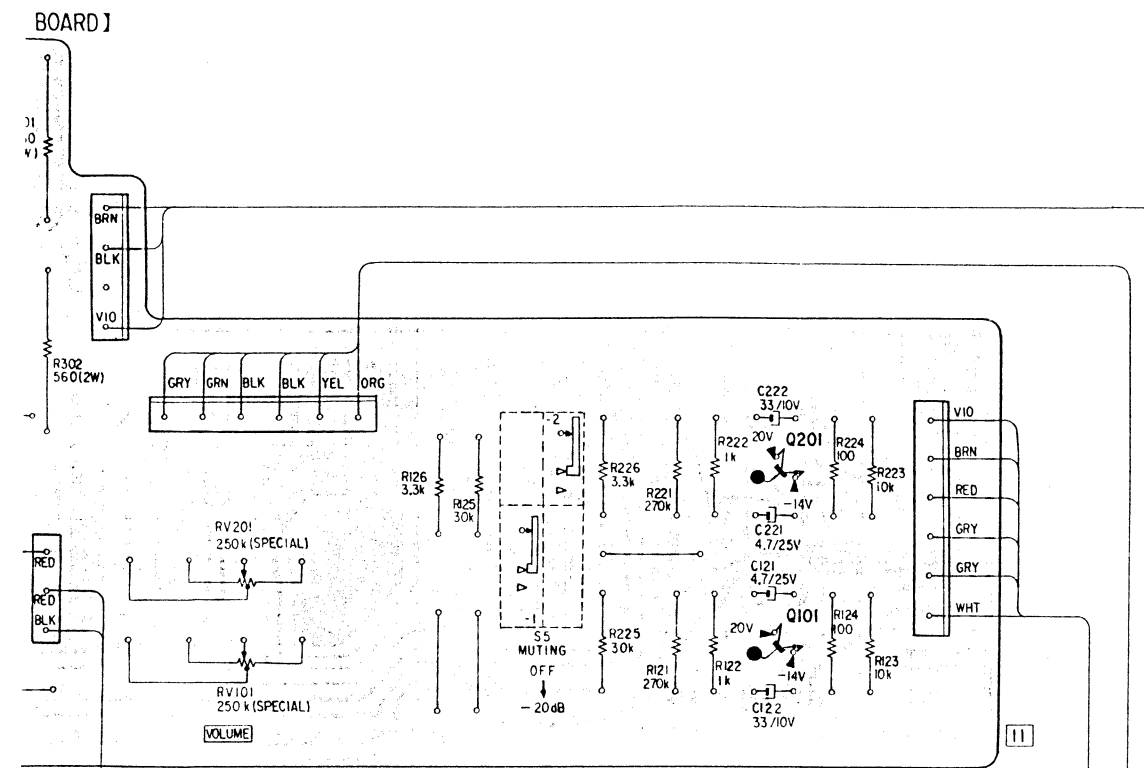

(POWER AMP BOARD)

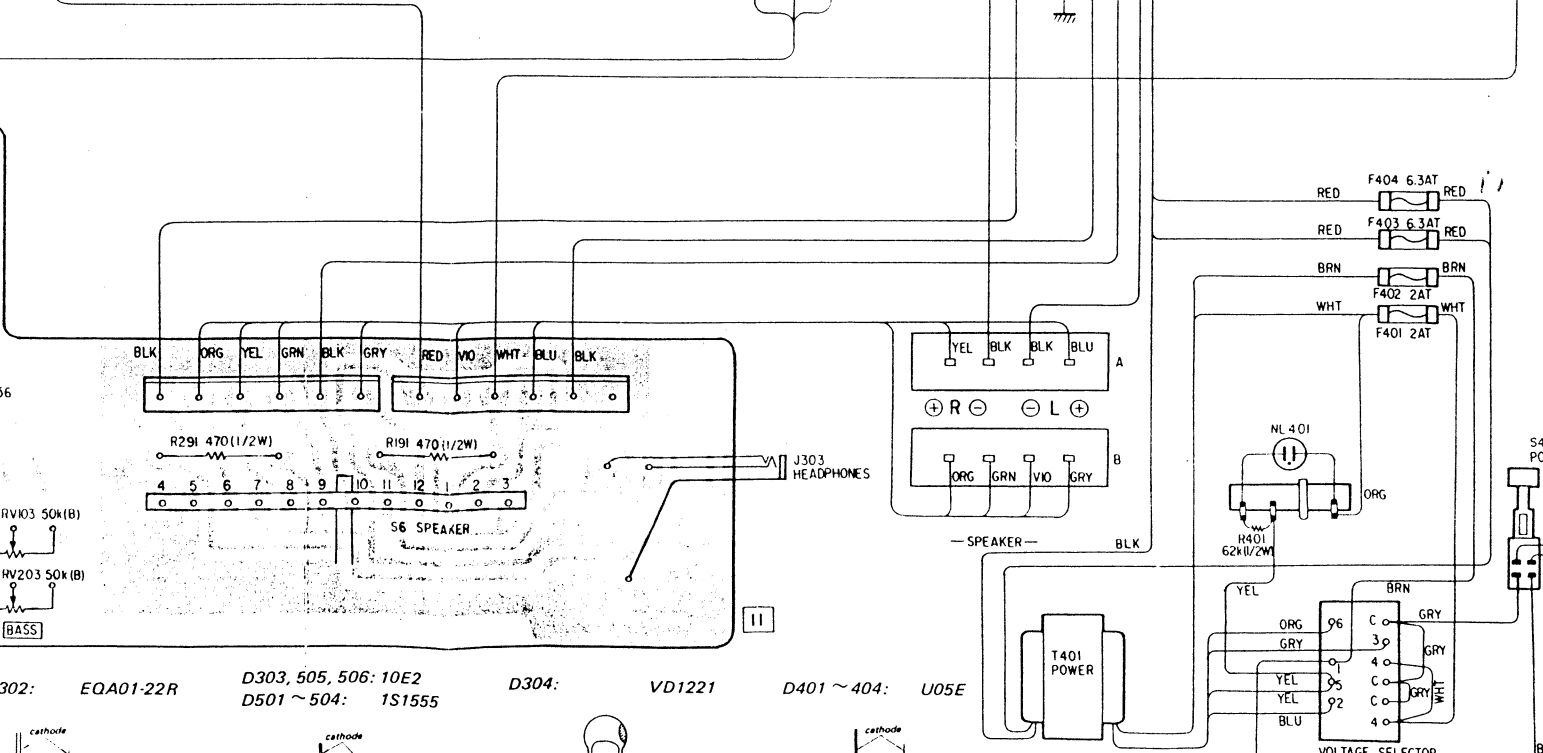
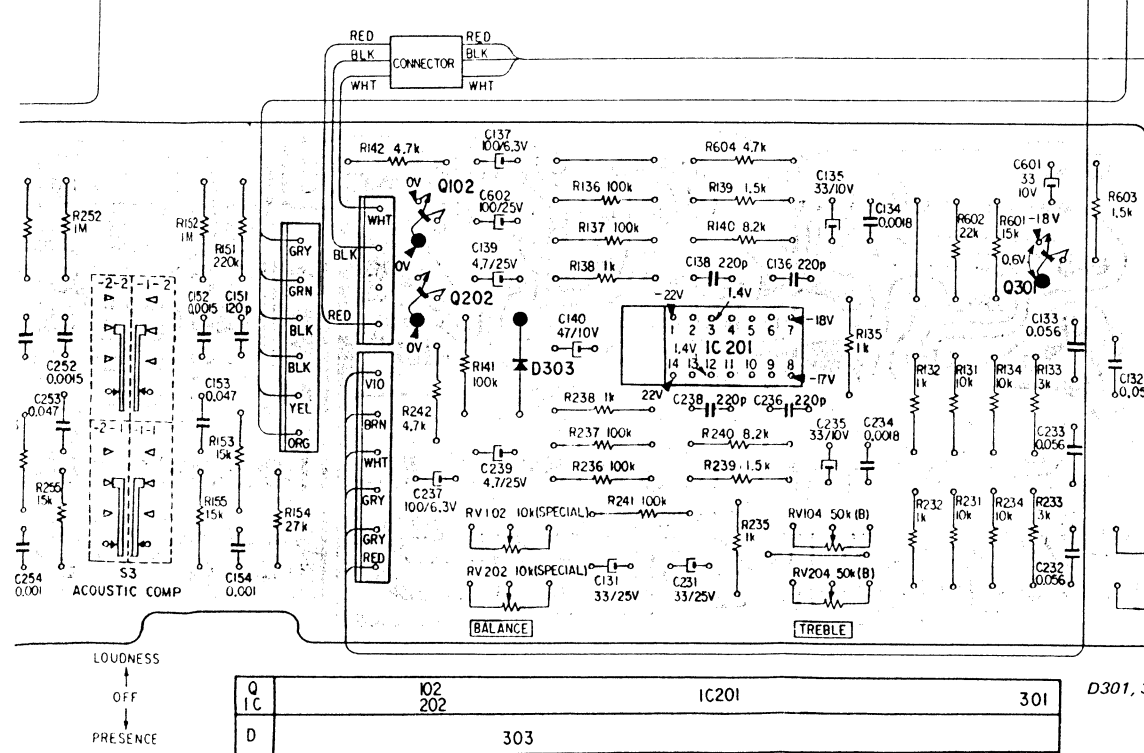
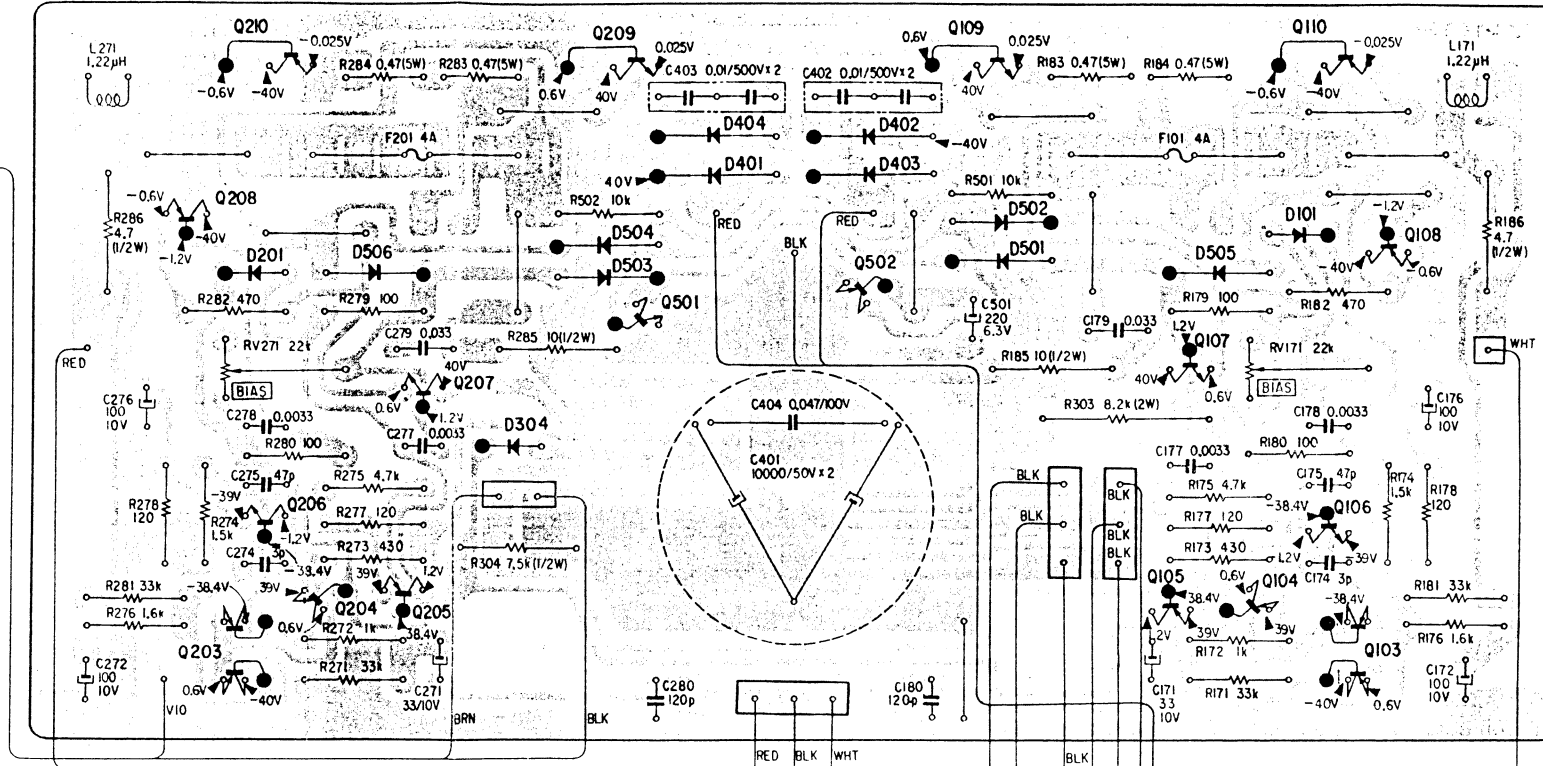

D301, 302: EQA01-22R D303, 505, 506: 10E2 D304: VD1221 D401 ~ 404: U05E

D501 ~ 504: 1S1555



Q	IC	102	202	IC201	301
D		303			

TA-2650 TA-2650

4-2. SCHEMATIC DIAGRAM

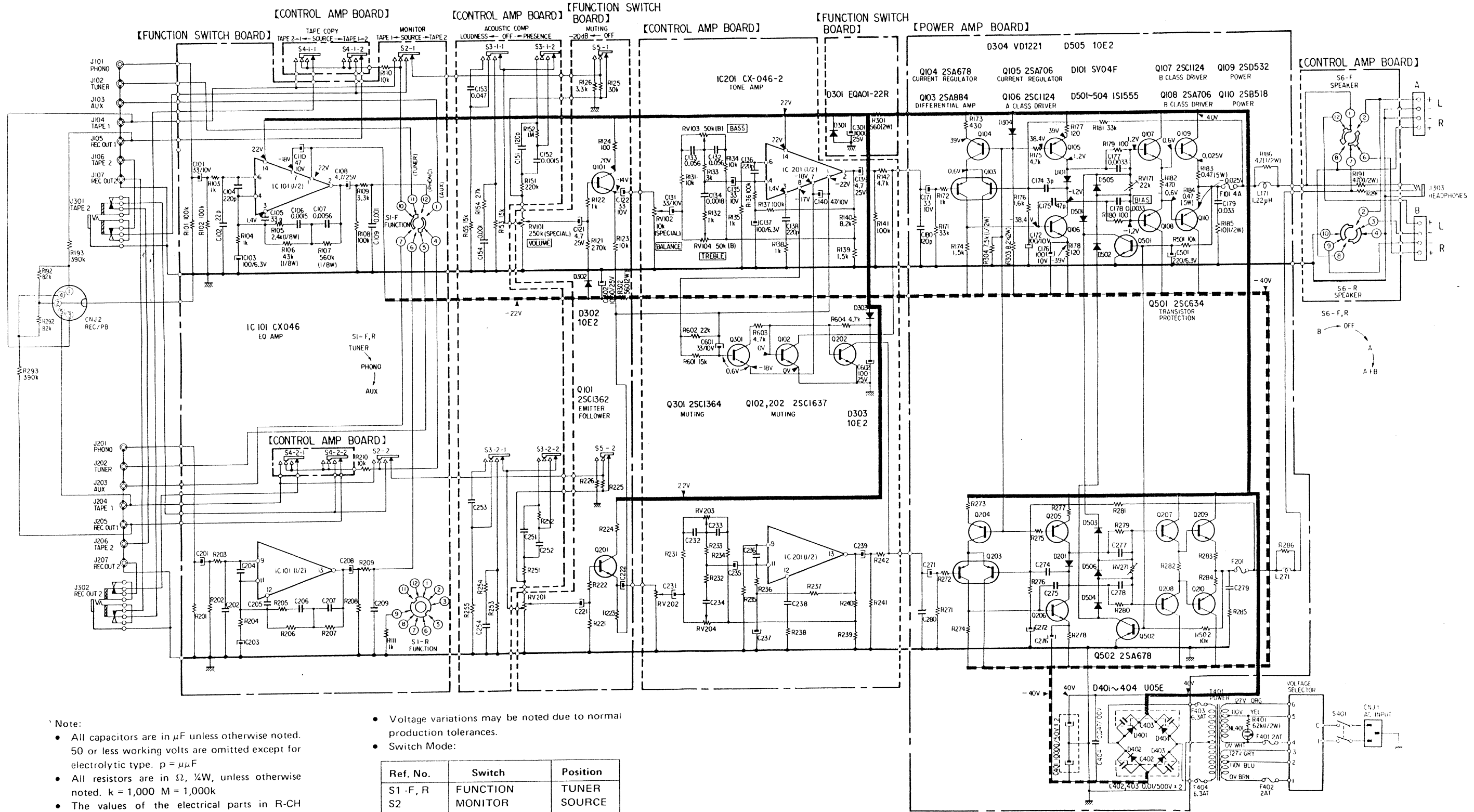

- Note:**
- All capacitors are in μF unless otherwise noted. 50 or less working volts are omitted except for electrolytic type. $p = \mu\text{F}$
 - All resistors are in Ω , $\frac{1}{4}\text{W}$, unless otherwise noted. $k = 1,000$ $M = 1,000k$
 - The values of the electrical parts in R-CH section are omitted from the diagram.
 - --- indicates chassis ground.
 - --- indicates B+ circuit.
 - --- indicates B- circuit.
 - Voltages are DC with respect to ground unless otherwise noted. Readings are taken under no-signal conditions with a VOM (20k Ω/V).

- Voltage variations may be noted due to normal production tolerances.
- Switch Mode:

Ref. No.	Switch	Position
S1 - F, R	FUNCTION	TUNER
S2	MONITOR	SOURCE
S3 -1-1 ~ 2	ACOUSTIC COMP	OFF
S3 -2-1 ~ 2		OFF
S4 -1-1 ~ 2	TAPE COPY	SOURCE
S4 -2-1 ~ 2		SOURCE
S5	MUTING	OFF
S6 - F, R	SPEAKER	B
S401	POWER	OFF

TA-2650 TA-2650

SECTION 5 EXPLODED VIEW

5.

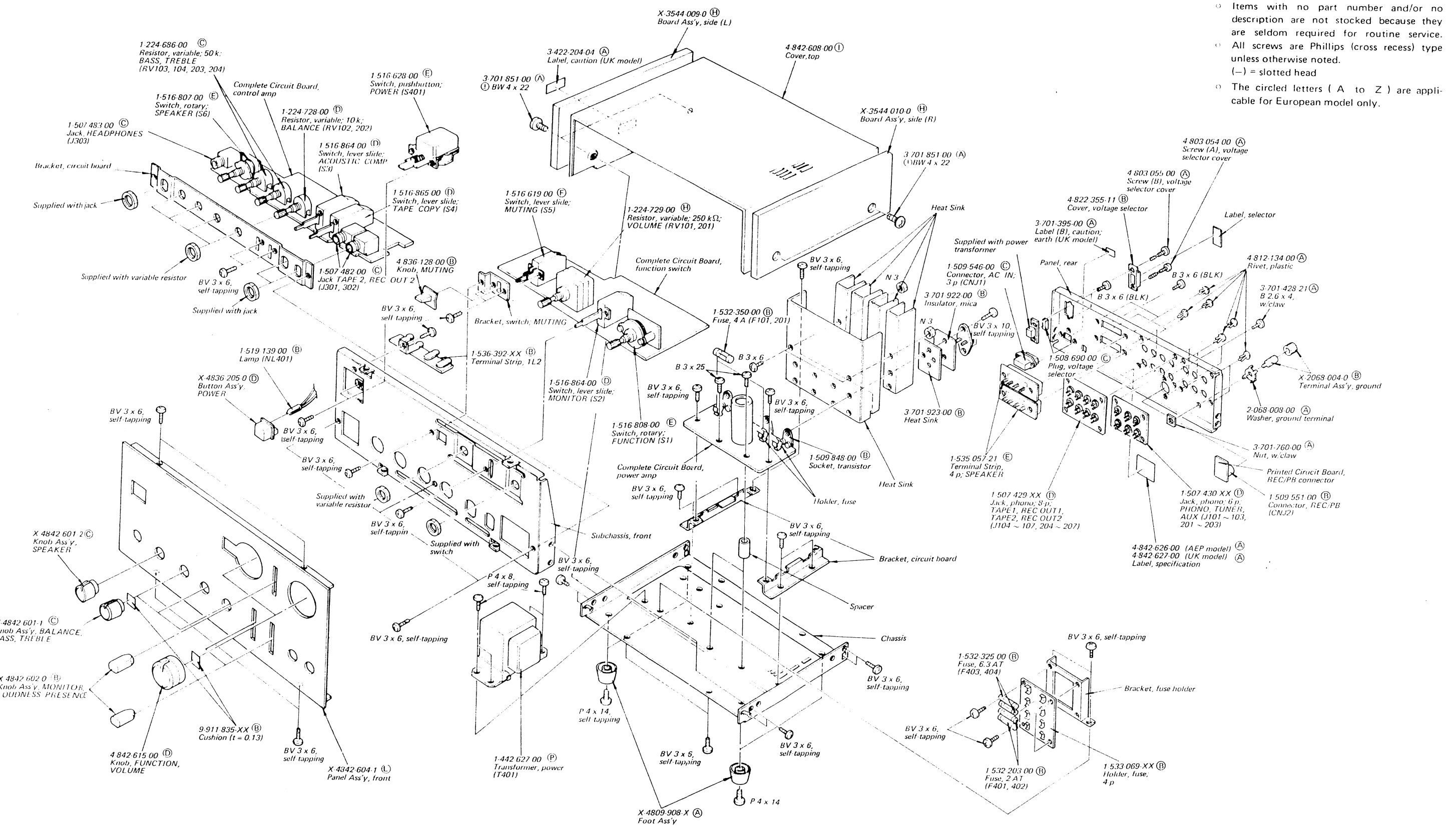

Note:

- Items with no part number and/or no description are not stocked because they are seldom required for routine service.
- All screws are Phillips (cross recess) type unless otherwise noted.
(-) = slotted head
- The circled letters (A to Z) are applicable for European model only.

SECTION 6
ELECTRICAL PARTS LIST

○ The circled letter (A to Z) are applicable for European model only.

Ref. No. Part No. Description

SEMICONDUCTORS

Transistors

Q101, 201 Ⓑ 2SC1362
Q102, 202 Ⓑ 2SC1637
Q103, 203 Ⓓ 2SA884
Q104, 204 Ⓒ 2SA678
Q105, 205 Ⓓ 2SA706

Q106, 206
Q107, 207 Ⓒ 2SC1124
Q108, 208 Ⓓ 2SA706
Q109, 209 Ⓔ 2SD532
Q110, 210 Ⓒ 2SB518

Q301 Ⓑ 2SC1364
Q501 Ⓑ 2SC634
Q502 Ⓒ 2SA678

IC's

IC101, 201 Ⓗ CX046

Diodes

D101, 201 Ⓑ SV04F
D301, 302 Ⓑ EQA01-22R
D303 Ⓑ 10E2
D304 Ⓑ VD1221
D401 ~ 404 Ⓒ U05E

D501 ~ 504 Ⓑ 1S1555
D505, 506 Ⓑ 10E2

CAPACITORS

All capacitors are in μ F and of mylar unless otherwise noted.

(p = μ F, elect = electrolytic)

50 and/or less working voltages are omitted except for tie type, electrolytic type.

C101, 201 1-121-926-11 Ⓐ 33 10V elect
C102, 202 1-102-959-11 Ⓐ 22p ceramic
C103, 203 1-121-413-11 Ⓐ 100 6.3V elect
C104, 204 1-102-978-11 Ⓐ 220p ceramic
C105, 205 1-102-963-11 Ⓐ 33p ceramic

Ref. No. Part No. Description

C106, 206 1-108-794-12 Ⓐ 0.0015
C107, 207 1-108-801-12 Ⓐ 0.0056
C108, 208 1-121-915-11 Ⓐ 4.7 25V elect
C109, 209 1-108-792-12 Ⓐ 0.001
C110 1-121-927-11 Ⓑ 47 10V elect

C121, 221 1-121-915-11 Ⓐ 4.7 25V elect
C122, 222
C131, 231 1-121-926-11 Ⓐ 33 10V elect

C132, 232
C133, 233 1-108-846-12 Ⓐ 0.056
C134, 234 1-108-828-12 Ⓐ 0.0018
C135, 235 1-121-926-11 Ⓐ 33 10V elect
C136, 236 1-102-978-11 Ⓐ 220p ceramic

C137, 237 1-121-413-11 Ⓐ 100 6.3V elect
C138, 238 1-102-978-11 Ⓐ 220p ceramic
C139, 239 1-121-915-11 Ⓐ 4.7 25V elect
C140 1-121-352-11 Ⓐ 47 10V elect

C151, 251 1-102-816-11 Ⓐ 120p ceramic
C152, 252 1-108-827-12 Ⓐ 0.0015
C153, 253 1-108-845-12 Ⓐ 0.047
C154, 254 1-108-825-12 Ⓐ 0.001

C171, 271 1-121-926-11 Ⓐ 33 10V elect
C172, 272 1-121-414-11 Ⓐ 100 10V elect
C174, 274 1-102-940-11 Ⓐ 3p ceramic
C175, 275 1-101-880-11 Ⓐ 47p ceramic
C176, 276 1-121-414-11 Ⓐ 100 10V elect

C177, 277
C178, 278 1-108-831-12 Ⓐ 0.0033
C179, 279 1-108-843-12 Ⓐ 0.033
C180, 280 1-102-816-11 Ⓐ 120p ceramic
C301, 302 1-123-066-11 Ⓑ 1000 25V elect

C401 1-125-100-11 Ⓚ 10000 x 2 50V elect
C402, 403 1-102-355-11 Ⓐ 0.01 500V elect
C404 1-108-634-12 Ⓐ 0.047 100V

C501 1-121-419-11 Ⓑ 220 6.3V elect
C601 1-121-926-11 Ⓐ 33 10V elect
C602 1-121-935-11 Ⓑ 100 25V elect

○ The circled letter (A to Z) are applicable for European model only.

Ref. No. Part No. Description

RESISTORS

All resistors are in Ω. Regular type, 1/4W carbon and composition resistors are omitted. Check the schematic diagram for resistance values. (k = 1000, M = 1000k)

R105, 205	1-246-482-11	Ⓐ	2.4k	1/8W	carbon
R106, 206	1-246-512-11	Ⓐ	43k	1/8W	carbon
R107, 207	1-246-539-11	Ⓐ	560k	1/8W	carbon
R183, 283 R184, 284	1-217-158-11	Ⓐ	0.47	5W	wire-wound
R185, 285	1-202-525-00	Ⓐ	10	1/2W	composition
R186, 286	1-202-517-00	Ⓐ	4.7	1/2W	composition
R191, 291	1-202-565-35	Ⓐ	470	1/2W	composition
R301, 302	1-206-658-11	Ⓐ	560	2W	metal oxide
R303	1-206-686-11	Ⓐ	8.2k	2W	metal oxide
R304	1-211-659-11	Ⓐ	7.5k	1/2W	carbon
R401	1-202-616-00	Ⓐ	62k	1/2W	composition
RV101, 201	1-224-729-00	Ⓗ	250k		variable, VOLUME
RV102, 202	1-224-728-00	Ⓓ	10k		variable, BALANCE
RV103, 203 RV104, 204	1-224-686-00	Ⓒ	50k		variable, BASS; TREBLE
RT171, 271	1-224-646-XX	Ⓑ	22k		adjustable

SWITCHES

S1	1-516-808-00	Ⓔ	Rotary, FUNCTION
S2, 3	1-516-864-00	Ⓓ	Lever Slide, MONITOR, ACOUSTIC COMP
S4	1-516-865-00	Ⓓ	Lever Slide, TAPE COPY
S5	1-516-619-00	Ⓕ	Lever Slide, MUTING
S6	1-516-807-00	Ⓔ	Rotary, SPEAKER
S401	1-516-628-00	Ⓔ	Pushbutton, POWER

Ref. No. Part No. Description

JACKS

J101 ~ 103 J201 ~ 203	1-507-430-XX	Ⓓ	Phono, 6-p; PHONO, TUNER, AUX
J104 ~ 107 J204 ~ 207	1-507-429-XX	Ⓓ	Phono, 8-p; TAPE 1, REC OUT 1, TAPE 2, REC OUT 2
J301, 302	1-507-482-00	Ⓒ	TAPE 2, REC OUT 2
J303	1-507-483-00	Ⓒ	HEADPHONES
CNJ1	1-509-546-00	Ⓒ	Connector, AC IN; 3-p
CNJ2	1-509-551-00	Ⓑ	Connector, REC/PB

MISCELLANEOUS

CP401	1-231-057-31	Ⓑ	Encapsulated Components, C-R
F101, 102	1-532-350-00	Ⓑ	Fuse, 4A
F401, 402	1-532-203-00	Ⓑ	Fuse, 2AT
F403, 404	1-532-325-00	Ⓑ	Fuse, 6.3AT
NL401	1-519-139-00	Ⓑ	Lamp
T401	1-442-627-00	Ⓔ	Transformer, power
	1-508-690-00	Ⓒ	Plug, voltage selector
	1-509-848-00	Ⓑ	Socket, transistor
	1-533-069-XX	Ⓑ	Holder, fuse; 4-p
	1-535-057-21	Ⓔ	Terminal Strip, 4-p; SPEAKER
	1-536-392-XX	Ⓑ	Terminal Strip, 1L2

ACCESSORIES

	1-534-819-00	Ⓒ	Cord, power (UK model)
	3-780-751-11	Ⓑ	Manual, instruction